

User manual  
Manuel d'utilisation  
Manual del usuario  
Benutzerhandücher  
Gebruikershandleidingen  
Manuale per l'utente  
Användarhandböckerna  
Brugermanual



# PHILIPS

## Important notes for users in the U.K.

### Mains plug

This apparatus is fitted with an approved 13 Amp plug. To change a fuse in this type of plug proceed as follows:

- 1 Remove fuse cover and fuse.
- 2 Fix new fuse which should be a BS1362 3 Amp, A.S.T.A. or BSI approved type.
- 3 Refit the fuse cover:

If the fitted plug is not suitable for your socket outlets, it should be cut off and an appropriate plug fitted in its place.

If the mains plug contains a fuse, this should have a value of 3 Amp. If a plug without a fuse is used, the fuse at the distribution board should not be greater than 3 Amp.

*Note: The severed plug must be disposed of to avoid a possible shock hazard should it be inserted into a 13 Amp socket elsewhere.*

### How to connect a plug

The wires in the mains lead are coloured with the following code: blue = neutral (N), brown = live (L).

- As these colours may not correspond with the colour markings identifying the terminals in your plug, proceed as follows:
  - Connect the blue wire to the terminal marked N or coloured black.
  - Connect the brown wire to the terminal marked L or coloured red.
  - Do not connect either wire to the earth terminal in the plug, marked E (or  $\perp$ ) or coloured green (or green and yellow).

Before replacing the plug cover, make certain that the cord grip is clamped over the sheath of the lead - not simply over the two wires.

### Copyright in the U.K.

Recording and playback of material may require consent. See Copyright Act 1956 and The Performer's Protection Acts 1958 to 1972.

## Italia

### DICHIARAZIONE DI CONFORMITA'

Si dichiara che l'apparecchio MCD510 Philips risponde alle prescrizioni dell'art. 2 comma 1 del D.M. 28 Agosto 1995 n. 548.

Fatto a Eindhoven

Philips Consumer Electronics  
Philips, Glaslaan 2  
6516 JB Eindhoven, The Netherlands

## Norge

Typeskilt finnes på apparatens underside.

**Observer: Nettbryteren er sekundert innkoplet. Den innebygde nettdelen er derfor ikke frakoplet nettet så lenge apparatet er tilsluttet nettkontakten.**

For å redusere faren for brann eller elektrisk støt, skal apparatet ikke utsettes for regn eller fuktighet.

## CAUTION

**Use of controls or adjustments or performance of procedures other than herein may result in hazardous radiation exposure or other unsafe operation.**

## VAROITUS

**Muiden kuin tässä esitettyjen toimintojen säädön tai asetusten muutto saattaa altistaa vaaralliselle säteilylle tai muille vaarallisille toiminnoille.**

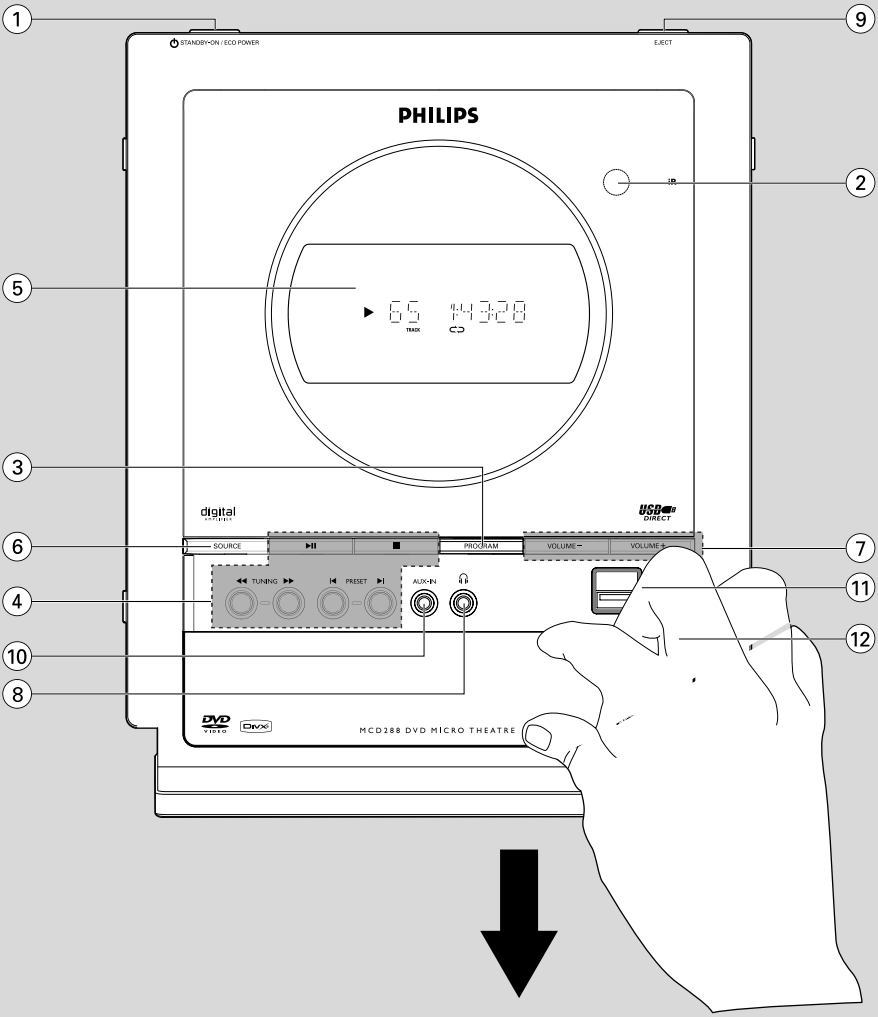

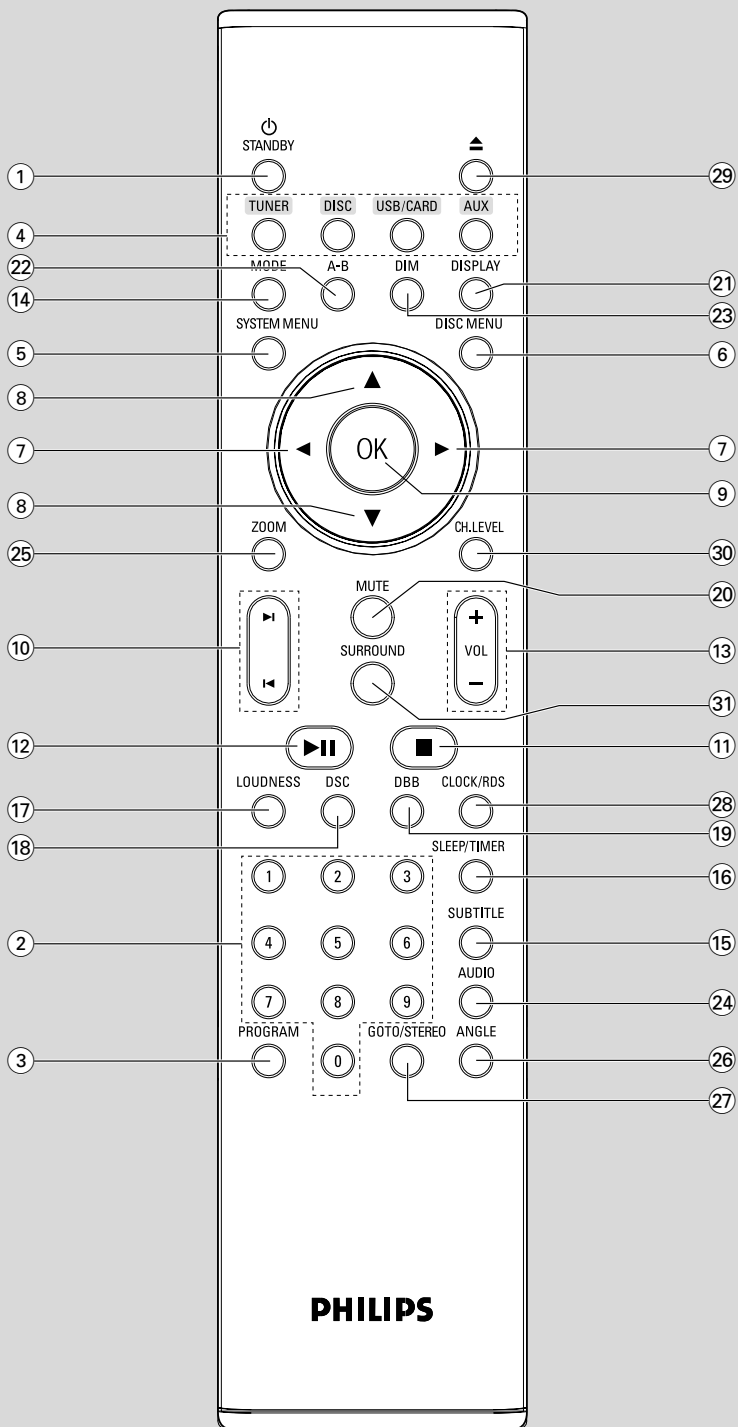

## DK

**Advarsel: Usynlig laserstråling ved åbning når sikkerhedsafbrydere er ude af funktion. Undgå udsættelse for stråling.**

**Bemærk: Netafbryderen er sekundært indkoblet og afbryder ikke strømmen fra nettet. Den indbyggede netdel er derfor tilsluttet til lysnettet så længe netstikket sidder i stikkontakten.**

## S

**Klass 1 laseraparater**

**Varning! Om apparaten används på annat sätt än i denna bruksanvisning specificerats, kan användaren utsättas för osynlig laserstråling, som överskrider gränsen för laserklass 1.**

**Observera! Stömbrytaren är sekundärt kopplad och bryter inte strömmen från nätet. Den inbyggda nätdelen är därför ansluten till elnätet så länge stickproppen sitter i vägguttaget.**

## SF

**Luokan 1 laserlaite**

**Varoitus! Laitteen käyttäminen muulla kuin tässä käyttöohjeessa mainitulla tavalla saattaa altistaa käyttäjän turvallisuusluokan 1 ylittävälle näkymättömälle lasersäteilylle.**

**Oikeus muutoksiin varataan. Laite ei saa olla alttiina tippu- ja roiskevedelle.**

**Huom. Toiminnanvalitsin on kytketty toisiopuolelle, eikä se kytke laitetta irti sähköverkosta. Sisäänrakennettu verkko-osa on kytkettynä sähköverkkoon aina silloin, kun pistoke on pistorasiasa.**

# Language Code

Abkhazian	6566	Inupiaq	7375	Pushto	8083
Afar	6565	Irish	7165	Russian	8285
Afrikaans	6570	Íslenska	7383	Quechua	8185
Amharic	6577	Italiano	7384	Raeto-Romance	8277
Arabic	6582	Ivrit	7269	Romanian	8279
Armenian	7289	Japanese	7465	Rundi	8278
Assamese	6583	Javanese	7486	Samoaan	8377
Avestan	6569	Kalaallisut	7576	Sango	8371
Aymara	6589	Kannada	7578	Sanskrit	8365
Azerbaijani	6590	Kashmiri	7583	Sardinian	8367
Bahasa Melayu	7783	Kazakh	7575	Serbian	8382
Bashkir	6665	Kernewek	7587	Shona	8378
Belarusian	6669	Khmer	7577	Shqip	8381
Bengali	6678	Kinyarwanda	8287	Sindhi	8368
Bihari	6672	Kirghiz	7589	Sinhalese	8373
Bislama	6673	Komi	7586	Slovensky	8373
Bokmål, Norwegian	7866	Korean	7579	Slovenian	8376
Bosanski	6683	Kuanyama; Kwanyama	7574	Somali	8379
Brezhoneg	6682	Kurdish	7585	Sotho; Southern	8384
Bulgarian	6671	Lao	7679	South Ndebele	7882
Burmese	7789	Latina	7665	Sundanese	8385
Castellano, Español	6983	Latvian	7686	Suomi	7073
Catalán	6765	Letzeburgesch;	7666	Swahili	8387
Chamorro	6772	Limburgan; Limburger	7673	Swati	8383
Chechen	6769	Lingala	7678	Svenska	8386
Chewa; Chichewa; Nyanja	7889	Lithuanian	7684	Tagalog	8476
中文	9072	Luxembourgish;	7666	Tahitian	8489
Chuang; Zhuang	9065	Macedonian	7775	Tajik	8471
Church Slavic; Slavonic	6785	Malagasy	7771	Tamil	8465
Chuvash	6786	Magyar	7285	Tatar	8484
Corsican	6779	Malayalam	7776	Telugu	8469
Česky	6783	Maltese	7784	Thai	8472
Dansk	6865	Manx	7186	Tibetan	6679
Deutsch	6869	Maori	7773	Tigrinya	8473
Dzongkha	6890	Marathi	7782	Tonga (Tonga Islands)	8479
English	6978	Marshallese	7772	Tsonga	8483
Esperanto	6979	Moldavian	7779	Tswana	8478
Estonian	6984	Mongolian	7778	Türkçe	8482
Euskara	6985	Nauru	7865	Turkmen	8475
Ελληνικά	6976	Navaho; Navajo	7886	Twi	8487
Faroese	7079	Ndebele, North	7868	Uighur	8571
Français	7082	Ndebele, South	7882	Ukrainian	8575
Frysk	7089	Ndonga	7871	Urdu	8582
Fijian	7074	Nederlands	7876	Uzbek	8590
Gaelic; Scottish Gaelic	7168	Nepali	7869	Vietnamese	8673
Gallegan	7176	Norsk	7879	Volapuk	8679
Georgian	7565	Northern Sami	8369	Walloon	8765
Gikuyu; Kikuyu	7573	North Ndebele	7868	Welsh	6789
Guarani	7178	Norwegian Nynorsk;	7878	Wolof	8779
Gujarati	7185	Occitan; Provençal	7967	Xhosa	8872
Hausa	7265	Old Bulgarian; Old Slavonic	6785	Yiddish	8973
Herero	7290	Oriya	7982	Yoruba	8979
Hindi	7273	Oromo	7977	Zulu	9085
Hiri Motu	7279	Ossetian; Ossetic	7983		
Hrvatski	6779	Pali	8073		
Ido	7379	Panjabi	8065		
Interlingua (International)	7365	Persian	7065		
Interlingue	7365	Polski	8076		
		Português	8084		

English ..... 8

Français ..... 45

Español ..... 84

Deutsch ..... 123

Nederlands ..... 162

Italiano ..... 201

Svenska ..... 240

Dansk ..... 277

**Manufactured under license from Dolby Laboratories.**

"Dolby", "Pro Logic" and the double-D symbol are trademarks of Dolby Laboratories.

This product incorporates copyright protection technology that is protected by method claims of certain U.S. patents and other intellectual property rights owned by Macrovision Corporation and other rights owners. Use of this copyright protection technology must be authorized by Macrovision Corporation, and is intended for home and other limited viewing uses only unless otherwise authorized by Macrovision Corporation. Reverse engineering or disassembly is prohibited.

**DivX, DivX Certified, and associated logos are trademarks of DivX Networks, Inc and are used under license.**



**Windows Media is a trademark of Microsoft Corporation.**

# Contents

## General Information

Features .....	10
Discs for playback .....	10
Supplied accessories .....	11
Environmental information .....	11
Care and safety information .....	11

## Installation

Step 1: Connecting speakers .....	13
Step 2: FM antenna connection .....	13
Step 3: Connecting TV .....	14-16
Using A/V OUT jack	
Using the video box	
Step 4: Placing the set and speakers .....	16
Step 5: Connecting the power cord .....	16
Optional: Connecting additional equipment .....	17-18
Listening to the playback of a non-USB device	
Using the VCR for recording DVDs	
Recording (digital)	
Connecting a USB device or memory card	

## Controls

Controls on the system .....	19
Controls on the remote control .....	19-20

## Preparations

Step 1: Inserting batteries into the remote control .....	21
Using the remote control to operate the system	
Step 2: Setting the clock .....	21
Step 3: Setting video preference .....	22
Setting up Progressive Scan feature (for Progressive Scan TV only)	
To deactivate Progressive manually	
Step 4: Setting language preference .....	24

## Basic Functions

Switching the system on/off .....	25
Switching the system to Eco Power Standby mode .....	25
Power-saving automatic standby .....	25
Sound control .....	25
DBB	
DSC	
LOUDNESS	
Volume control .....	25
Dimming the display screen .....	25

## Disc Operations

Playing discs .....	26
Using the disc menu .....	26
Basic playback controls .....	26-28
Pausing playback	
Selecting a track/chapter/title	
Resuming playback from the last stopped point	
Zoom	
Repeat	
Shuffle play mode	
Repeat A-B	
Slow Motion	
Program	
Forward/Reverse Searching	
Time search & search by chapter/track number	
Information display during playback	
Special disc features .....	28
Playing a Title	
Camera Angle	
Changing the Audio Language	
Changing the Audio Channel	
Subtitles	
Playing MP3 disc .....	29
General operation	
Playback selection	
Playing JPEG Picture CD .....	29
General operation	
Playback selection	
Special JPEG features .....	30
Zoom picture	
Slide show playback modes	
Playback with multi-angles	
Playing a DivX disc .....	30



---

## System Menu Options

Basic operations .....	31
SYSTEM SETUP .....	31-33
TV SYSTEM	
SCREEN SAVER	
TV TYPE	
PASSWORD	
RATING	
DEFAULT	
DIVX(R) VOD registration code	
LANGUAGE SETUP .....	33
VIDEO SETUP .....	33-34
BRIGHTNESS	
CONTRAST	
HUE	
SATURATION	
AUDIO SETUP .....	34
DIGITAL OUT	
DOWNMIX	
3D PROCESSING	
LPCM	
NIGHT MODE	

---

## Radio Reception

Tuning to radio stations .....	35
Programming radio stations .....	35
Automatic programming .....	35
Manual programming .....	35
Tuning to preset radio stations .....	35
RDS .....	36
Setting the RDS clock .....	36

---

## External Sources

Using a non-USB device .....	37
Using a USB mass storage device .....	37-38

---

## Clock/Timer

Clock setting .....	39
Timer setting .....	39
Sleep timer setting .....	39

---

## Specifications .....

---

## Troubleshooting .....

---

## Glossary .....

# General Information

## Features

Your DVD Micro Theatre with 2.1 channel full digital amplifier creates the same dynamic sound qualities that you find in full-fledged cinemas and incorporates some of the best features in home theater technology.

### Other features include:

Built-in Dolby Digital decoder, supporting Incredible Surround and DSC sound setting.

### Additional Component Connections

Lets you connect other audio and audio/visual components to the system so you can use the system's surround sound speakers.

### Parental control (rating level)

Lets you set a rating level so that your children cannot watch a DVD that has a rating higher than you set.

### Sleep timer

Enables the system to switch to standby mode automatically at a preset time.

### Night Mode

Lets you compress the dynamic range, reducing the difference in loudness between different sounds in Dolby Digital mode.

### Progressive Scan

Provides high quality flicker-free images for film based sources. When a picture refreshes, its vertical resolution can double to 525 lines.

#### Note:

– To fully enjoy the progressive scan feature, you need a progressive scan TV.

## Discs for playback

### Your DVD System will play:

- Digital Video Discs (DVDs)
- Video CDs (VCDs)
- Super Video CDs (SVCDs)
- Digital Video Discs + Rewritable (DVD+RW)
- Compact Discs (CDs)
- Picture (Kodak, JPEG) files on CDR(W)
- Windows Media Audio (WMA)
- DivX(R) disc on CD-R(W):
- DivX 3.11, 4.x and 5.x
- Supported MP3-CD format.

- ISO 9660 / UDF format
- Max. title/album name –10 characters
- Max. title number plus album is 255.
- Max. nested directory is 8 levels.
- The max. album number is 32.
- The max. MP3 track number is 999.
- Supported sampling frequencies for MP3 disc: 32 kHz, 44.1 kHz, 48 kHz.
- Supported Bit-rates of MP3 disc are: 32, 64, 96, 128, 192, 256 (kbps).



The following formats can't be supported

- The files like \*.VMA, \*.AAC, \*.DLF, \*.M3U, \*.PLS, \*.WAV,
- The discs recorded under Joliet format

## Region Codes

DVDs must be labeled as shown below in order to play on this DVD system. You cannot play discs that are labeled for other regions.



#### Notes:

- For mixed mode discs, only one mode will be selected for playback according to the recording format.
- If you are having trouble playing a certain disc, remove the disc and try a different one. Improperly formatted discs will not play on this system.

## Supplied accessories

- A/V cord (R/W/Y)
- Component video cables (red/blue/green)
- FM wire antenna
- External video box
- Power cord
- 15-pin D-Sub cable (with one end fixed on the main set)
- Stand
- Remote Control and two AAA batteries
- This instruction booklet and a quick start guide

## Environmental information

All unnecessary packaging has been omitted. We have tried to make the packaging easy to separate into three materials: cardboard (box), polystyrene foam (buffer) and polyethylene (bags, protective foam sheet).

Your system consists of materials which can be recycled and reused if disassembled by a specialised company. Please observe the local regulations regarding the disposal of packaging materials, exhausted batteries and old equipment.

## Care and safety information

### Avoid high temperatures, moisture, water and dust

- Do not expose the system, batteries or discs to humidity, rain, sand or excessive heat (caused by heating equipment or direct sunlight).
- No objects filled with liquids, such as vases, shall be placed on the apparatus.
- No naked flame sources, such as lighted candles, should be placed on the apparatus.
- The apparatus shall not be exposed to dripping or splashing.

### Avoid condensation problem

- The lens may cloud over when the player is suddenly moved from cold to warm surroundings, making it impossible to play a disc. Leave the player in the warm environment until the moisture evaporates.

### Do not block the vents

- Do not operate the system in an enclosed cabinet and allow about 10 cm (4 inches) of free space all around the player for adequate ventilation.
- The ventilation should not be impeded by covering the ventilation openings with items, such as newspapers table-cloths, curtains, etc.

### Cleaning the cabinet

- Use soft cloth slightly moistened with a mild detergent solution. Do not use a solution containing alcohol, spirits, ammonia or abrasives.

### Cleaning discs

- To clean a CD, wipe it in a straight line from the center towards the edge using soft and lint-free cloth. A cleaning agent may damage the disc.
- Write only on the printed side of a CDR(W) and only with a soft felt-tipped pen.
- Handle the disc by its edge. Do not touch the surface.



### Finding a suitable location

- Place the player on a flat, hard, stable surface.
- Install this unit near the AC outlet and where the AC power plug can be reached easily.

# Installation

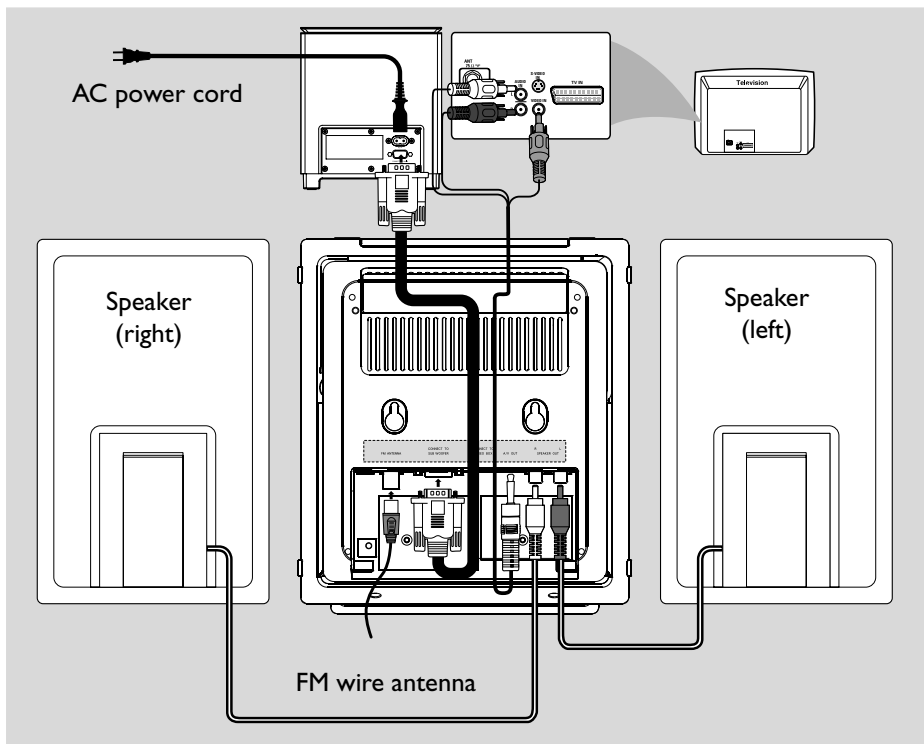

## IMPORTANT!

- The type plate is located at the rear of the system.
- Before connecting the AC power cord to the wall outlet, ensure that all other connections have been made.
- Never make or change any connections with the power switched on.
- High voltage! Do not open. You run the risk of getting an electric shock.
- The machine does not contain any user-serviceable parts.
- Modification of the product could result in hazardous radiation of EMC or other unsafe operation.

## Note:

- Before installation is finished, it is not recommended to remove the protective plastic film attached to the surface of the front panel to avoid any scratch caused during installation.

To avoid overheating of the system, a safety circuit has been built in. Therefore, your system may switch to Standby mode automatically under extreme conditions. If this happens, let the system cool down before reusing it (not available for all versions).

## Step 1: Connecting speakers

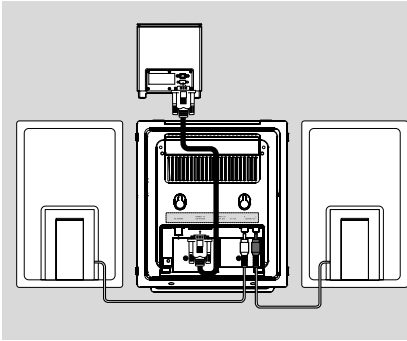

- 1 Place the main set with the front side facing down on a flat and firm surface. Then remove the detachable cover on the back of the set to expose the terminals available for connection.
- 2 Connect the two front speaker cables to the **SPEAKER OUT** terminals: right speaker to "R" and left speaker to "L".
- 3 Connect one end of the 15-pin D-Sub cable (the other end is fixed on the **CONNECT TO SUBWOOFER** terminal on the back of the main set) to the **CONNECT TO MAIN** terminal of the subwoofer by matching the pins. Fix the two screws on the connectors to ensure firm connection.

### Notes:

- Ensure that the speaker cables are correctly connected. Improper connections may damage the system due to short-circuit.
- For optimal sound performance, use the supplied speakers.
- Do not connect more than one speaker to any one pair of +/- speaker terminals.
- Do not connect speakers with an impedance lower than the speakers supplied. Please refer to the **SPECIFICATIONS** section of this manual.

## Step 2: FM antenna connection

Connect the supplied FM antenna to the **FM AERIAL** terminal. Fully extend and adjust the position of the antenna for optimal reception.

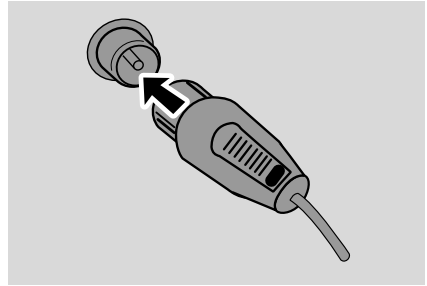

- For better FM stereo reception, connect an outdoor FM antenna to the FM AERIAL (FM ANTENNA) terminal.

### Notes:

- This system does not support MW reception.

# Installation

## Step 3: Connecting TV

### IMPORTANT!

- You only need to make one video connection from the following options, depending on the capabilities of your TV.
- Connect the DVD system directly to the TV.

### Using AV OUT jack

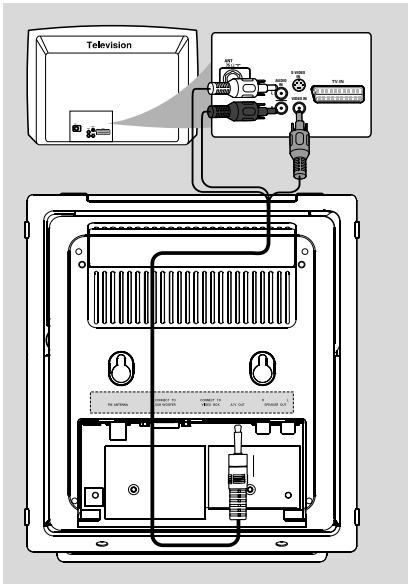

- 1 Connect the end of the supplied AV cord with only one connector to the **AV OUT** jack of the DVD system.
- 2 For the other end, connect the video output connector (yellow) to the video input jack (or labeled as A/V In, CVBS, Composite or Baseband) on the TV. To hear the sound of this DVD system through your TV, connect the audio connectors (white/ red) to the audio input jacks on the TV.

### Using the video box

### IMPORTANT!

- A **SCART** connection will let you use features both **Audio and Video** on the **DVD Player**.

The supplied video box provides you with more TV connection options.

- First connect the 9-pin connector of the supplied video box to the **CONNECT TO VIDEO BOX** jack on the back of the set by matching the pins.

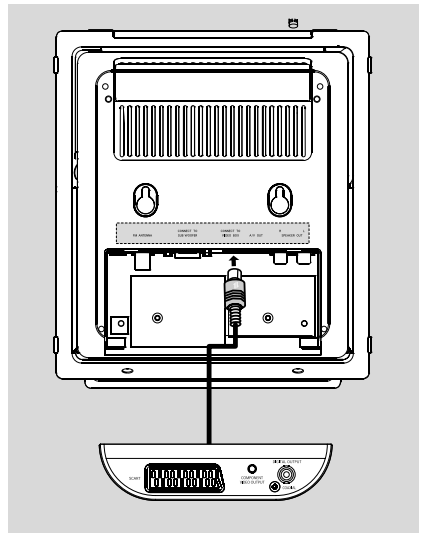

## Using Component Video jacks (Y Pb Pr)

### IMPORTANT!

– The progressive scan video quality is only possible when using Y Pb Pr, and a progressive scan TV is required.

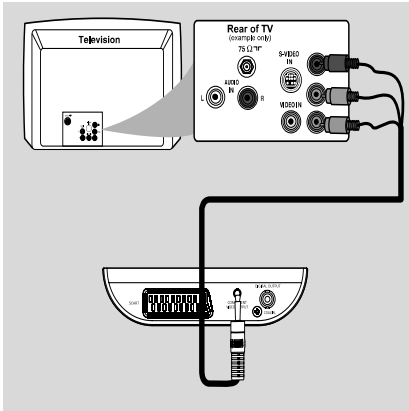

- 1 Use component video cables (red/blue/green) to connect the **COMPONENT VIDEO OUTPUT (Pr/Cr Pb/Cb Y)** jack to the corresponding Component video input jacks (or labeled as Y Pb/Cb Pr/Cr or YUV) on the TV.
- 2 If you are using a Progressive Scan TV (TV must indicate Progressive Scan or ProScan capability), to activate TV Progressive Scan, please refer to your TV user manual. For DVD system Progressive Scan function, see "Preparations-Setting up Progressive Scan feature".

### Note:

– If your TV does not support Progressive Scan, you will not be able to view the picture.  
Press **SYSTEM MENU** on the remote to exit the system menu and then **DISC** to exit progressive scan.

## Using SCART jack

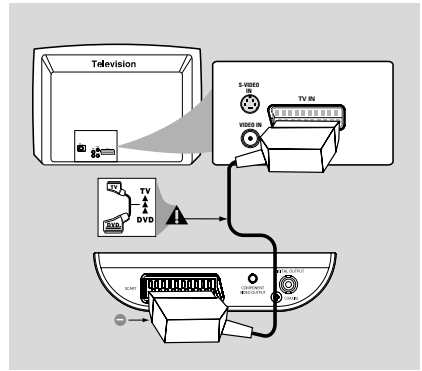

- Use the SCART cable (black) to connect the DVD Player's SCART jack (**SCART**) to the corresponding SCART input jacks on the TV.

### Note:

– Ensure that the "TV" indication on SCART cable is connected to the TV set and "DVD" indication on SCART cable is connected to the DVD Player.

# Installation

## Step 4: Placing the set and speakers

- 1 After finishing all rear connections, mount the detachable cover on the back of the set until hearing a click to avoid cable clutter.

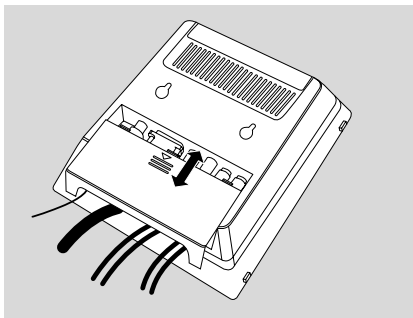

- 2 Align the side marked **PRESS▼** of the stand to the slots at the bottom of the set.

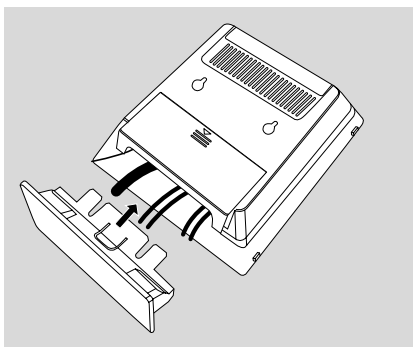

- 3 Push the stand down into the slots until you hear a click.
- 4 Place the set upright on the desktop with the support of the stand.
- 5 Extend the bracket on the back of each front speaker as shown so that the front speakers can stand firmly on the desktop.
- 6 Place the subwoofer on the floor near an AC outlet.

### Note:

– To remove the stand from the set, while pressing down **PRESS▼**, pull the stand out from the slots.

## Step 5: Connecting the power cord

After everything is connected properly, plug in the AC power cord to the power outlet.

Never make or change any connection with the power switched on.

## Optional: Connecting additional equipment

### Listening to the playback of a non-USB device

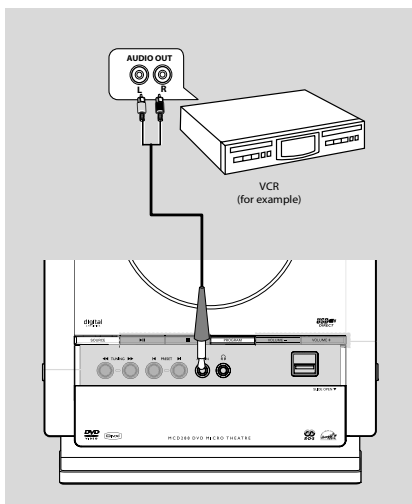

- Connect the system's **AUX-IN** jack to the **AUDIO OUT** jacks on another audio/visual device (such as a VCR, Laser Disc player or cassette desk) using a "single-to-double" cinch cable (with one end providing a 3.5" connector for connection to the **AUX-IN** jack while the other end providing two white/red connectors for connection to the other device's AUDIO OUT jacks).



## Using the VCR for recording DVDs

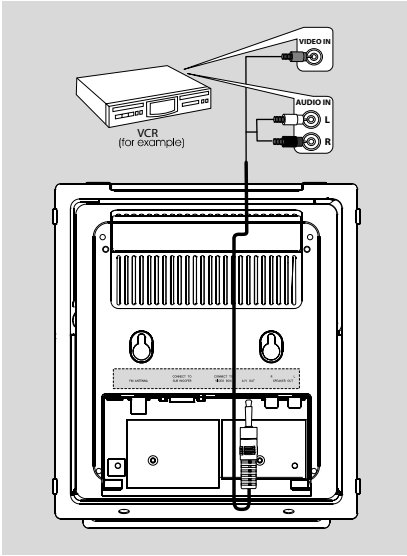

- 1 Connect the end of the supplied AV cord with only one connector to the **AV OUT** jack of the DVD system.
- 2 For the other end, connect the video output connector (yellow) to the **VIDEO IN** jack on the VCR and the audio connectors (white/ red) to the corresponding audio input jacks on the VCR. This will allow you to make analogue stereo (two channel, right and left) recordings.

## Recording (digital)

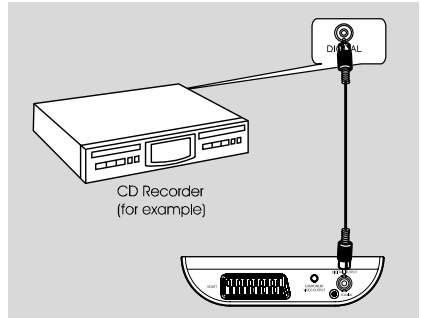

- Connect the **COAXIAL (DIGITAL OUTPUT)** jack on the video box to the **DIGITAL IN** jack on a digital recording device (such as DTS Digital Theatre compatible, with Dolby Digital decoder).  
Before starting operation, set the **DIGITAL OUT** according to the audio connection. (See "DIGITAL OUT".)

## Connecting a USB device or memory card

### IMPORTANT!

– Before connecting the USB plug, first slide down the movable baffle as shown on Page 3 to expose the  jack.

By connecting a USB mass storage device (including USB flash memory, USB flash players or memory cards) to the Hi-Fi system, you can enjoy the device's stored music through the powerful speakers of Hi-Fi system.

- Insert the USB device's USB plug into the  socket on the set.

### for the devices with USB cables:

- 1 Insert one plug of the USB cable (not supplied) to the  socket on the set.
- 2 Insert the other plug of the USB cable to the USB output terminal of the USB device.

### for the memory card:

- 1 Insert the memory card into a card reader (not supplied).
- 2 Use a USB cable (not supplied) to connect the card reader into the  socket on the set.

## Disposal of your old product

Your product is designed and manufactured with high quality materials and components, which can be recycled and reused.

When this crossed-out wheeled bin symbol is attached to a product it means the product is covered by the European Directive 2002/96/EC

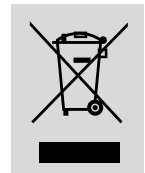



Please inform yourself about the local separate collection system for electrical and electronic products.

Please act according to your local rules and do not dispose of your old products with your normal household waste. The correct disposal of your old product will help prevent potential negative consequences for the environment and human health.



## Controls on the system

- ① **ECO POWER/STANDBY ON** 
  - to switch the system on or to Eco power/normal standby mode.
- ② **iR sensor**
  - infrared sensor for remote control.
- ③ **PROGRAM**
  - DVD/VCD/CD/MP3-CD/USB: enters the program menu.
  - Picture CD: during playback, to select a slide show mode.
  - Tuner: programs preset radio stations.
- ④ **Mode Selection**
  - ..... In DISC/USB mode, to stop playback or clear a program.
  - ..... for Demo (*on the system only*) to activate/deactivate the demonstration.
  - ▶|..... In DISC/USB mode, to start or interrupt playback.

**PRESET**  



Disc/USB: skips to the previous/next chapter/ title/track.

Tuner: selects a preset radio station.





**TUNING**  

Tuner

  - press to tune to a lower/higher radio frequency gradually.
  - press and hold, then release the key to start automatic search for a radio frequency downward/upward.
  - Disc/USB
  - searches fast backward/forward.
- ⑤ **Display screen**
  - to view the current status of the system.
- ⑥ **SOURCE**
  - to select the respective sound source :TUNER, DISC, USB/CARD or AUX.
- ⑦ **VOLUME -/+**
  - adjusts the volume upward/downward.
  - adjusts the hours and minutes in clock/timer setting mode.
  - selects a source in timer setting mode.
- ⑧ 
  - to connect a headphone.
- ⑨ **EJECT**
  - ejects a disc from the disc loader:

- ⑩ **AUX-IN**
  - connects an external non-USB device.
- ⑪  **USB DIRECT**
  - jack for the external USB mass storage device.
- ⑫ **SLIDE OPEN** 
  - slides down to expose some buttons and jacks on the front panel.

## Controls on the remote control

- ① **STANDBY** 
  - to switch the system on or to Eco power/normal standby mode.
- ② **Numeric Keypad (0-9)**
  - inputs a track/title/chapter number of the disc.
- ③ **PROGRAM**
  - DVD/VCD/CD/MP3-CD/USB: enters the program menu.
  - Picture CD: during playback, to select a slide show mode.
  - Tuner: programs preset radio stations.
- ④ **SOURCE**
  - to select the respective sound source :TUNER, DISC, USB/CARD or AUX.
- ⑤ **SYSTEM MENU** (disc mode only)
  - to enter or exit the system menu bar.
- ⑥ **DISC MENU** (disc mode only)
  - DVD/VCD: enters or exits the disc contents menu.
  - VCD2.0: switches the playback control mode on or off.
- ⑦  
  - Tuner
  - press to tune to a lower/higher radio frequency gradually.
  - press and hold, then release the key to start automatic search for a radio frequency downward/upward.
  - Disc/USB
  - searches fast backward/forward.
  - In DISC mode, to select a movement direction in the disc menu or system menu bar.
- ⑧  
  - In DISC mode, to select a movement direction in the disc menu or system menu bar.
  - selects different slow playback modes for a VCD/ SVCD/DVD.

\* = Press and hold the button for more than three seconds.

# Controls

- ⑨ **OK**
  - to exit or confirm the selection.
- ⑩ **◀/▶**
  - Disc: skips to the previous/next chapter/title/track.
  - Tuner: selects a preset radio station.
- ⑪ **■**
  - In DISC/USB mode, to stop playback or clear a program.
- ⑫ **▶▶**
  - In DISC/USB mode, to start or interrupt playback.
- ⑬ **VOL +/-**
  - adjusts the volume upward/downward.
  - adjusts the hours and minutes in clock/timer setting mode.
  - selects a source in timer setting mode.
- ⑭ **MODE**
  - selects various repeat modes or the shuffle play mode for a disc.
- ⑮ **SUBTITLE**
  - selects a subtitle language.
- ⑯ **SLEEP/TIMER**
  - Standby mode**
    - sets time for switching on the system automatically.
  - Power-on mode**
    - sets the sleep timer function (auto off).
- ⑰ **LOUDNESS**
  - enables or disables automatic loudness adjustment.
- ⑱ **DSC**
  - selects different types of preset sound equalizer settings (CLASSIC, JAZZ, ROCK, POP or FLAT; for DVD: NORMAL, CONCERT, DRAMA, ACTION or SCI-FI).
- ⑲ **DBB**
  - enables or disables bass enhancement.
- ⑳ **MUTE**
  - to interrupt or resume sound reproduction.
- ㉑ **DISPLAY**
  - displays information on TV screen during playback.
- ㉒ **A-B**
  - for VCD/CD/USB: to repeat a specific section within the same track.
  - for DVD: to repeat a specific section in a disc.
- ㉓ **DIM**
  - selects different levels of brightness for the display screen.
- ㉔ **AUDIO**
  - for VCD
    - sets Stereo, Mono-Left or Mono-Right sound mode.
  - for DVD
    - selects an audio language.
- ㉕ **ZOOM**
  - DVD/VCD/Picture CD: enlarges or reduces a picture or active image on the TV screen.
- ㉖ **ANGLE**
  - selects a DVD camera angle.
- ㉗ **GOTO/STEREO**
  - In DISC mode, to fast search in a disc by entering a time, title, chapter or track.
  - **FM**: sets stereo or mono sound mode.
- ㉘ **CLOCK/RDS**
  - Standby mode
    - \*– sets the system clock.
  - Playback mode
    - displays the system clock.
  - For tuner**
    - displays RDS information.
- ㉙ **▲**
  - ejects a disc from the disc loader.
- ㉚ **CH.LEVEL (unavailable for this version)**
- ㉛ **SURROUND (unavailable for this version)**

## Notes for remote control:

- **First, select the source you wish to control by pressing one of the source select keys on the remote control (DISC or TUNER, for example).**
- **Then select the desired function (▶▶, ◀, ▶▶ for example).**

\* = Press and hold the button for more than three seconds.

## IMPORTANT!

- Make sure to complete the preparation procedures before operating the system.

### Step 1: Inserting batteries into the Remote Control

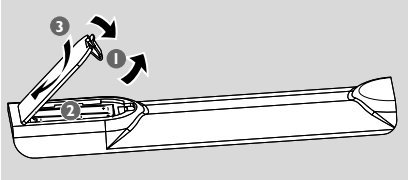

- 1 Open the battery compartment.
- 2 Insert two AAA batteries following the indications (+/-) inside the compartment.
- 3 Close the cover.

### Using the Remote Control to operate the Player

- 1 Aim the Remote Control directly at the remote sensor (IR) on the front panel.
- 2 Do not put any objects between the Remote Control and the DVD Player while operating the DVD Player.

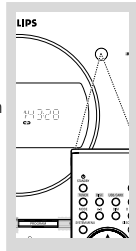

## CAUTION!

- Remove batteries if they are exhausted or if the Remote Control is not being used for a long time.
- Do not use old and new or different types of batteries in combination.
- Batteries contain chemical substances, so they should be disposed of properly.

### Step 2: Setting the clock

- 1 Go to Standby mode.
- 2 Press and hold **CLOCK/RDS** on the remote. → "CLOCK SET" is displayed briefly. Then, the hour digits flash on the display screen.
- 3 Press **VOLUME +/- (VOL +/-)** on the remote) to set the hours.
- 4 Press **CLOCK/RDS** again. → The minute digits flash on the display screen.
- 5 Press **VOLUME +/- (VOL +/-)** on the remote) to set the minutes.
- 6 Press **CLOCK/RDS** to confirm the clock setting.

#### Notes:

- This system only supports 24-hour mode.
- The clock setting will be erased when the system is disconnected from the power supply.
- The system will exit clock setting mode if no button is pressed within 30 seconds.

## Step 3: Setting video preference

### IMPORTANT!

– **Make sure you have completed all the necessary connections. (See "Connections-Connecting TV".)**

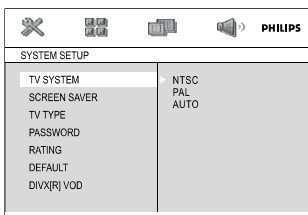

Turn on the TV set and set it to the correct Video-In channel.

→ You may go to channel 1 on your TV set, then press the channel button repeatedly until you see the Video In channel.

→ Or, you can use the TV remote control to select different video modes.

→ Or, set TV to channel 3 or 4 if you are using an RF modulator.

1 In stop mode or during playback, press **SYSTEM MENU**.

2 Press ◀/▶/▲/▼ on the remote control to toggle through the functions and select your preferential option.

→ Move to **SYSTEM SETUP** and press ▼.

→ Move to one of the following and press ▶.

### – Setting TV SYSTEM

Allows you to select the colour system matching the connected TV set.

#### NTSC

– If the connected TV is NTSC system, select this mode. It will change the video signal of a PAL disc and output in NTSC format.

#### PAL

– If the connected TV is PAL system, select this mode. It will change the video signal of a NTSC disc and output in PAL format.

#### AUTO

– If the connected TV is multi system, select this mode. The output format will be in accordance with the video signal of the disc.

### – Setting TV TYPE

Select the aspect ratio of the TV to be connected.

#### 4:3 PS (Pan and Scan mode)

– If you have a conventional TV set and your DVD is not formatted for widescreen viewing, use this setting. A wide picture is displayed on the whole TV screen with a portion automatically cut off.

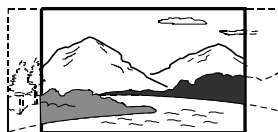

#### 4:3 LB (Letterbox mode)

– If you have a conventional TV set and your DVD is formatted for widescreen viewing, use this setting. A wide picture with bands displayed on the upper and lower portions of the TV screen.



#### 16:9 (Wide screen mode)

– If you have a widescreen TV set, use this setting (you must also set your widescreen TV to "full size") available on a disc, then the disc's own preference will be used.

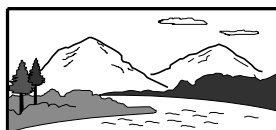

#### Note:

*The format you select must be available on the disc. If it is not, the setting for TV Type will not affect the picture during playback.*

#### To exit the menu

Press **SYSTEM MENU** again.





## Setting up Progressive Scan feature (for Progressive Scan TV only)

The progressive scan display twice the number of frames per seconds than interlaced scanning (ordinary normal TV system). With nearly double the number of lines, progressive scan offers higher picture resolution and quality.

### IMPORTANT!

**Before enabling the progressive scan feature, you must ensure:**

- 1) Your TV can accept progressive signals, a progressive scan TV is required.
- 2) You have connected the DVD player to your TV using Y Pb Pr (see "Installation-Step 3: Connecting TV- Using Component Video jacks".)

- 1 Turn on your TV.
- 2 Turn off your TV progressive scan mode or turn on interlaced mode (refer to your TV user manual).
- 3 Press **STANDBY-ON**  (**STANDBY**  on the remote) to turn on the DVD player.
- 4 Select the correct Video Input channel.  
→ The DVD background screen appears on the TV.
- 5 Press **SYSTEM MENU**.
- 6 Press   repeatedly to select "**VIDEO SETUP**".
- 7 Select "**TV MODE**" to "**P-SCAN**", then **OK** to confirm.  
→ The instruction menu appears on the TV.

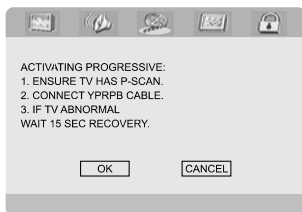



- 8 Press   to highlight OK in the menu and press **OK** to confirm.

**There will be a distorted picture on your TV at this state until you turn on the progressive scan mode on your TV.**

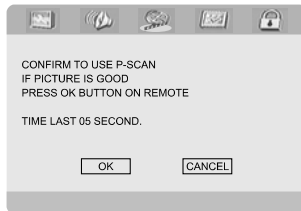
- 9 Turn on your TV progressive scan mode (refer to your TV user manual).  
→ The below menu appears on the TV.



- 10 Press   to highlight OK in the menu and press **OK** to confirm.  
→ The setup is complete now and you can start enjoy the high quality picture.

## To deactivate Progressive manually

- 1 **When the distorted sign still appears on the TV**, it may be due to the connected TV does not accept progressive signals, and progressive is set by mistake. You must reset the unit to interlace format.
- 1 Turn off your TV progressive scan mode or turn on to interlaced mode (refer to your TV user manual).
- 2 Press **SYSTEM MENU** on the remote to exit the system menu and then **DISC** to exit progressive scan.  
→ The DVD blue background screen will appear.

## Step 4: Setting language preference

You can select your preferred language settings so that this DVD Micro System will automatically switch to the language for you whenever you load a disc. If the language selected is not available on the disc, the language set by default will be used instead. But the menu language of the DVD Micro System cannot be changed once selected.

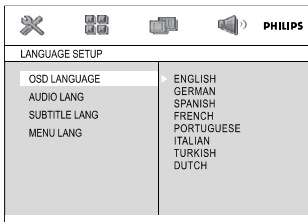

- 1 In stop mode or during playback, press **SYSTEM MENU**.
- 2 Press ◀/▶/▲/▼ on the remote control to select your preferred option.
  - Move to **LANGUAGE SETUP** and press ▼.
  - Move to one of the following and press ▶.

### **OSD LANGUAGE** (On-Screen Display)

Switches the display language on the TV screen. Select the language from the displayed list.

### **AUDIO LANG** (DVD only)

Switches the display language of the sound track. Select the language from the displayed list.

### **SUBTITLE LANG** (DVD only)

Switches the display language of the subtitle. Select the language from the displayed list.

### **MENU LANG** (DVD only)

Select the language for the DVD menu.

When the selected language is not recorded in the DVD, one of the recorded languages will be selected automatically (except for OSD).

You can reset all the DVD settings except for Rating.

If the language selected is not available on the disc, the original language designated by each disc will be selected.



- 3 Press ▲/▼ to select a language and press **OK**.
- 4 Repeat **steps 2~3** for other settings.

### **To exit the menu**



Press **SYSTEM MENU** again.





## Switching the system on/off

- Press **ECO POWER/STANDBY-ON**  (**STANDBY**  on the remote).  
→ "HELLO" is displayed briefly. The system will switch to the last selected source.
- Press **DISC, TUNER** or **AUX** on the remote.  
→ The system will switch to the selected source.

## To switch the system to standby mode

- Press **ECO POWER/STANDBY-ON**  (**STANDBY**  on the remote).  
→ The interactive sound settings, last selected source and tuner presets will be retained in the player's memory.

## Switching the system to Eco Power Standby mode

- Press **ECO POWER/STANDBY-ON**  in the active mode.  
→ The system enters Eco power standby (the ECO POWER LED is on) or normal standby with clock display.
- The volume level (up to a maximum volume level of 12), interactive sound settings, last selected mode, source and tuner presets will be retained in the player's memory.
- If the system is normal standby with clock display, press and hold **ECO POWER/STANDBY-ON**  for 3 seconds or more to switch to Eco power standby or vice versa.

## Power-saving automatic standby

As a power-saving feature, the system will automatically switch to Standby mode if you do not press any buttons within 15 minutes after a disc has stopped playing.

## Sound Control

**DBB, DSC and LOUDNESS sound features cannot be activated at the same time.**

### DBB (Dynamic Bass Boost)

DBB enhances the bass response.

- Press **DBB** on the remote to enable/disable DBB feature.

→ Some discs might be recorded in high modulation, which causes a distortion at high volume. If this occurs, switch off DBB or reduce the volume.

### DSC (Digital Sound Control)

DSC provides a different type of preset sound equalizer setting.

- Press **DSC** on the remote repeatedly to select: CLASSIC, JAZZ, ROCK, POP or FLAT (for DVD: NORMAL, CONCERT, DRAMA, ACTION or SCI-FI).

### LOUDNESS

LOUDNESS feature enables the system to automatically increase the treble and bass sound effect at low volume (the higher the volume, the lower the treble and bass increase).

- Press **LOUDNESS** on the remote to enable or disable LOUDNESS feature.  
→  icon appears/disappears after this feature is enabled/disabled.  
→ **LOUD ON** or **LOUD OFF** is displayed.

## Volume control

Press **VOLUME +/- (VOL +/-)** on the remote) to increase or decrease the volume level.  
→ "VOLUME xx" is displayed on the display panel. "xx" denotes the volume level.

## To listen through the headphone

- Connect the headphone plug to the  socket on the front panel of the DVD player.  
→ The speakers will be muted.

## To switch off the volume temporarily

- Press **MUTE** on the remote.  
→ Playback will continue without sound and "MUTING" flashes.
- To activate sound reproduction, you can:
  - press **MUTE** again;
  - adjust the volume controls;
  - change source.

## Dimming the display screen

- Press **DIM** repeatedly to select different levels of brightness for the display screen.

## IMPORTANT!

– This system is designed for regular discs. Therefore, do not use any accessories such as disc stabiliser rings or disc treatment sheets, etc., as offered on the market, because they may jam the disc mechanism.

– Do not move the system during playback. Doing so may damage the system.



– DVD discs and players are designed with regional restrictions. Before playing a disc, make sure the disc matches the regional code of your player.

– According to the format requirement of DVD or VCD, some operations may be different or restricted.

– Do not push on the disc tray or put any objects other than disc in the slot loader. Doing so may cause the disc player malfunction.

– If  appears on the TV screen when a button is pressed, it means the function is not available on the current disc at the current time.





## Playing discs

- 1 Connect the power cords of the system and TV (or any optional stereo or AV receiver) to a power outlet.
- 2 Turn on the TV power and set to the correct Video In channel. (See "Setting up the TV".)
- 3 Press **STANDBY-ON**  (**STANDBY**  on the remote).  
→ You should see the blue Philips DVD background screen on the TV.
- 4 Insert a disc into the slot loader.  
→ Make sure the label side is facing you.  
→ Make sure you have removed any other disc from the slot loader.
- 5 Playback will start automatically (depending on the disc type).  
→ If a disc menu appears on the TV, see "Using the Disc Menu".  
→ If the disc is locked by parental control, you must enter your four-digit password. (See "SYSTEM SETUP-PASSWORD".)
- 6 At any time, simply press  to stop playback.

## Using the disc menu

For disc with Table Of Contents, a menu may appear on the TV screen once you load the disc.

### To select a playback feature or item

- Use / / /  and **OK** or **Numeric Keypad (0-9)** on the remote.  
→ Playback will start automatically.

### To access or exit the menu

- Press **DISC MENU** on the remote.

### For VCD with Playback Control (PBC) feature (version 2.0 only)

PBC playback allows you to play Video CDs interactively, following the menu on the display.



- During playback, press **DISC MENU**.  
→ If PBC was ON, it will switch to OFF and continue playback.  
→ If PBC was OFF, it will switch to ON and return to menu screen.

## Basic playback controls

### Pausing playback (DVD/VCD/CD/MP3/WMA)

- 1 During playback, press **▶||**.  
→ Playback will pause and sound will be muted.
- 2 Press **▶||** again to resume.

### Selecting a track/chapter/title (DVD/VCD/CD/MP3/WMA)

- 1 Press **PRESET** /  during playback to go to the previous or next chapter/title/track.
- 2 To go directly to any chapter/ title/track, enter the chapter/ title/track number using the **Numeric Keypad (0-9)**.

### Resuming playback from the last stopped point (DVD/VCD/CD/MP3/WMA)

- In stop mode and when a disc has not been removed, press **▶||**.

### To cancel resume mode

- In stop mode, press  again.

## Zoom (DVD/VCD/JPEG)

Zooming allows you to enlarge or reduce the video image during playback.

- 1 Press **ZOOM** repeatedly to enlarge or reduce the playback video image.
- 2 Press **◀◀/▶▶/▲/▼** to pan across the TV screen.

## Different play modes: SHUFFLE and REPEAT (DVD/VCD/CD/MP3/WMA)

- Press **REPEAT** repeatedly to choose a repeat mode during playback.

### For DVD CHAPTER

– to repeat playback of the current chapter.

### TITLE

– to repeat playback of the current title.

### OFF

– switches off the repeat mode.

### For VCD/MP3/CD

#### REP 1

– to repeat playback of the current track.

#### REP ALL

– to repeat playback of the whole disc.

#### REPEAT ALL SHUFFLE

– to play the whole disc repeatedly in random order.

### OFF

– switches off the repeat mode.

## Repeat A-B (DVD/VCD/CD/MP3/WMA)

- 1 Press **A-B** at your chosen starting point.
- 2 Press **A-B** again at your chosen end point.
  - The section A and B can be set only within the same chapter/track.
  - The section will now repeat continuously.
- 3 To exit the sequence, press **A-B** again.
  - "A-B CANCEL" is displayed on the TV screen.

## Slow Motion (DVD/VCD)

- 1 Press **▲/▼** on the remote during playback to select the required forward speed: 1/2, 1/3, 1/4, 1/5, 1/6 or 1/7.
  - Sound will be muted.
- 2 To return to normal speed, press **▶▶**.

## Program (not for Picture CD)

To select favourite tracks/chapters for playback in preferred sequence.

PROG						
T	C	T	C	T	C	T
1	--:--	5	--:--	9	--:--	13
2	--:--	6	--:--	10	--:--	14
3	--:--	7	--:--	11	--:--	15
4	--:--	8	--:--	12	--:--	16
PLAY				CLEAR		

- 1 Press **PROGRAM** to enter the program mode.
- 2 Use the **Numerical Keypad (0-9)** to directly input the tracks or chapters.
- 3 Move the cursor by pressing **◀/▶/▲/▼** to select **PLAY**.
- 4 Press **OK** to start playback.

# Disc Operations

## Forward/Reverse Searching (DVD/VCD/CD/MP3/WMA)

- 1 Press **TUNING** ◀◀▶▶▶▶ (◀/▶ on the remote) during playback to select the required speed: X2, X4, X8 or X20 (backward or forward).  
→ Sound will be muted.
- 2 To return to normal speed, press **PLAY/PAUSE** ▶||

## Time search & search by chapter/track number (DVD/VCD/CD/MP3/WMA)

- 1 Press **GOTO/STEREO** until the time or chapter/track edit box appears.
- 2 Enter hours, minutes and seconds from left to right in the time edit box using the **Numeric Keypad (0-9)** on the remote.  
OR  
Enter your desired chapter/track number in the chapter/track edit box using the **Numeric Keypad (0-9)** on the remote.

## Information display during playback (DVD/VCD/CD/MP3/WMA)

- During playback, press **DISPLAY** to show disc information on the TV screen.

### For DVD/VCD/CD

- Elapsed playback time of the current track/ title.
  - Remaining playback time of the current track/ title.
  - Total playback time of the whole disc.
  - Elapsed playback time of the whole disc.
  - Display off.
- OR
- Remaining playback time of the current track/ title.
  - Elapsed playback time of the whole disc.
  - Remaining playback time of the whole disc.
  - Display off.

### For MP3 CD

- Elapsed playback time of the current track.
- Remaining playback time of the current track.

## Special disc features

### Playing a Title (DVD)

- 1 Press **DISC MENU**.  
→ The disc title menu appears on the TV screen.
- 2 Use ◀/▶/▲/▼ to select a play option.
- 3 Press **OK** to confirm.

### Camera Angle (DVD)

- Press **ANGLE** repeatedly to select different desired angle.

### Changing the Audio Language (for DVD recorded with multiple languages)

- Press **AUDIO** repeatedly to select different audio languages.

### Changing the Audio Channel (for VCD only)

- Press **AUDIO** to select the available audio channels provided by the disc (Mono Left, Mono Right or Stereo).

### Subtitles (DVD)

- Press **SUBTITLE** repeatedly to select different subtitle languages.

## Playing MP3/WMA/JPEG Disc

### IMPORTANT!

– You have to turn on your TV and set to the correct Video In channel. (See "Setting up the TV".)

## Playing MP3/WMA disc

### General operation

- 1 Load an MP3/WMA disc.  
→ A data disc menu appears on the TV screen and playback starts automatically from the first track.
- 2 Press ◀ to move to the album column on the left of the TV screen, then use ▲/▼ to select an album and press **OK** to open it.

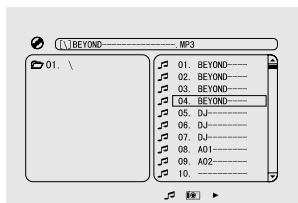

- 3 Press ▶ to move to the track column on the right of the TV screen and then use ▲/▼ to highlight a track; or directly use the Numeric Keypad (0-9) to input a track number.
- 4 Press **OK** to confirm.  
→ The playback will start from the selected track to the end of the album.

### Note:

The disc reading time may exceed 10 seconds due to large number of songs compiled onto the disc.

### Playback selection

During playback, you can:

- Press **PRESET** ◀/▶ to select another track in the current album.
- Press ▶|| repeatedly to pause/resume playback.

## Playing JPEG Picture CD

### General operation

- 1 Load a JPEG Picture CD.  
→ A data disc menu appears on the TV screen and playback starts automatically from the first file.
- 2 Press ◀ to move to the folder column on the left of the TV screen, then use ▲/▼ to select a folder and press **OK** to open it.
- 3 Press ▶ to move to the file column on the right of the TV screen and then use ▲/▼ to highlight a file; or directly use the **Numeric Keypad (0-9)** to input a file number.
- 4 Press **OK** to confirm.  
→ The playback will start from the selected picture to the end of the folder.

### Playback selection

During playback, you can:

- Press **PRESET** ◀/▶ to select another file in the current folder.
- Use ◀/▶/▲/▼ on the remote to rotate/flip the picture files.
- Press ▶|| repeatedly to pause/resume playback.
- Press ■ to stop playback and return to the disc content menu.

## Special JPEG features

### Zoom picture (JPEG)

- During playback, press **ZOOM** repeatedly to display the picture with different scales (2, 3, 4, 1/2, 1/3, 1/4 and OFF).
- Use ◀▶/▲▼ to view the zoomed picture.

### Slide show playback modes (JPEG)

- During playback, press **PROGRAM** repeatedly to select different slide-show playback modes:  
Mode 0: NONE  
Mode 1: WIPETOP  
Mode 2: WIPE BOTTOM  
Mode 3: WIPE L  
Mode 4: WIPE R  
Mode 5: DIAGONAL L TOP  
Mode 6: DIAGONAL R TOP  
Mode 7: DIAGONAL L BOTTOM  
Mode 8: DIAGONAL R BOTTOM  
Mode 9: EXTEND CENTER H  
Mode 10: EXTEND CENTER V  
Mode 11: COMPRESS CENTER H  
Mode 12: COMPRESS CENTER V  
Mode 13: WINDOW H  
Mode 14: WINDOW V  
Mode 15: EDGE TO CENTER  
Mode 16: RANDOM

### Playback with multi-angles (JPEG)

- During playback, press ◀▶/▲▼ to rotate the picture on the TV screen.  
▲: flip the picture vertically.  
▼: flip the picture horizontally.  
◀: rotate the picture anti-clockwise.  
▶: rotate the picture clockwise.

## Playing a DivX disc

This DVD player supports the DivX movie playback that you download from your computer onto a CD-R/RW (see "System Menu Options-DIVX(R) VOD registration code" for more information).

- 1 Load a DivX disc.  
→ Playback will start automatically. If not press ▶||
  - 2 If the DivX movie contains external subtitles, the subtitle menu will appear on the TV screen for your selection.
- In this case, pressing **SUBTITLE** on the remote control will turn on or off the subtitle.
  - If multilingual subtitles are embedded on the DivX disc, pressing **SUBTITLE** will change the subtitle language during playback.

### Note:

- Subtitle files with the following filename extensions (.srt, .smi, .sub, .ssa, .ass) are supported but do not appear on the file navigation menu.
- The subtitle filename have to be the same as the filename of the movie.

## Basic operations

- 1 Press **SYSTEM MENU** to enter the Setup Menu.
- 2 Press **◀▶** to select a page to be set.
- 3 Press **▲▼** to highlight an option.
- 4 Enter its submenu by pressing **▶** or **OK**.
- 5 Move the cursor by pressing **▲▼** to highlight the selected item.
  - In cases of value setting, press **▲▼** to adjust values.
- 6 Press **OK** to confirm.

### To return to the upper-level menu

- Press **◀**.

### To exit from the menu

- Press **SYSTEM MENU** again.
  - The settings will be stored in the player's memory even if the player is switched off.

#### Note:

– Some of the features in the System Menu Options are described in "Preparations".

## SYSTEM SETUP

The options included in SYSTEM SETUP page are: "TV SYSTEM", "SCREEN SAVER", "TV TYPE", "PASSWORD", "RATING", "DEFAULT" and "DIVX(R) VOD".

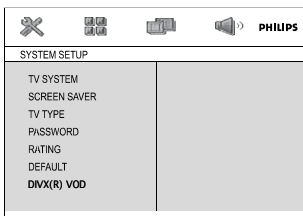

### TV SYSTEM

See "Preparations-Step 3: Setting video preference" for details.

### SCREEN SAVER

This function is used to turn the screen saver on or off.

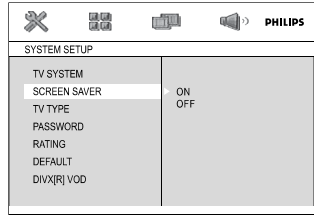

→ **ON**: In STOP, PAUSE or No DISC mode, if no actions are performed about 3 minutes, the screen saver will be activated.

→ **OFF**: Screen saver is disabled.

### TV TYPE

See "Preparations-Step 3: Setting video preference" for details.

### PASSWORD

You can enter your four-digit password to activate or deactivate rating control.

→ "🔒" is displayed if rating control is activated.

→ "🔓" is displayed if rating control is deactivated.

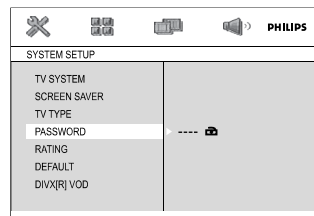

### To change password

- 1 Move to "PASSWORD" and press **▶** or **OK** to enter its submenu.
- 2 If "🔒" is displayed, enter the default password (0000) and press **OK** to unlock.
- If "🔓" is displayed, directly proceed with Step 4 and ▶
- 3 Enter your new four-digit password using **Numeric Keypad (0-9)** on the remote.
- 4 Press **OK** to confirm and the new password takes effect.

#### Note:

– The default password (0000) is always active even if the password has been changed.

# System Menu Options

## RATING

Some DVDs may have a parental level assigned to the complete disc or to certain scenes on the disc. This feature lets you set a playback limitation level.

The rating levels are from 1 to 8 and are country dependent. You can prohibit the playing of certain discs that are not suitable for your children or have certain discs played with alternative scenes.

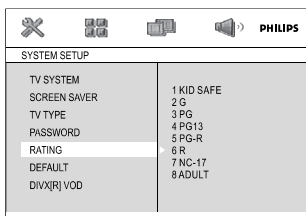

- VCD, SVCD and CD have no level indication, so parental control function has no effect on those kinds of discs. This applies to most illegal DVD discs.
- ① Press ▲/▼ to highlight "RATING".
- ② Enter its submenu by pressing ►.
- ③ Use ▲/▼ to highlight a rating level for the disc inserted.  
→ DVDs that are rated above the level you selected will not play unless you enter your four-digit password and choose a higher level rating.

### Note:

– Some DVDs are not encoded with a rating though the movie rating may be printed on the Disc cover. The rating level feature does not work for such Discs.

## Rating explanations

### 1 KID SAFE

– Suitable for children.

### 2 G

– General Audience; recommended as acceptable for viewers of all ages.

### 3 PG

– Parental Guidance suggested.

### 4 PG 13

– Material is unsuitable for children under age 13. Parental Guidance suggested.

### 5-6 PG-R, R

– Parental Guidance – Restricted; recommended that parents restrict children under 17 from viewing or allow them to view only when supervised by a parent or adult guardian.

### 7 NC-17

– No children under age 17; not recommended for children under age 17.

### 8 ADULT

– Material for adults only; viewed only by adults due to graphic sexual scenes, violence, or language.

## DEFAULT

Setting the "Default" function will reset all options and your personal settings to the factory defaults and all your personal settings will be erased.

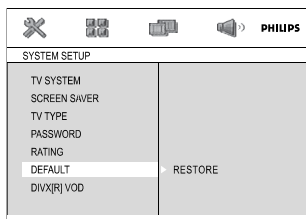

- ① Press ▲/▼ to highlight "DEFAULT".
- ② Highlight "RESTORE" by pressing ►.
- ③ Press **OK** to confirm selection.

### Caution!

– **When this function is activated, all settings will be reset to factory defaults.**



## DIVX(R) VOD registration code

Philips provides you the DivX® VOD (Video On Demand) registration code that allows you to rent and purchase videos using the DivX® VOD service.

For more information, visit us at [www.divx.com/vod](http://www.divx.com/vod).

- In SYSTEM SETUP page, press ▲ ▼ to highlight DIVX(R) VOD, then press ► or **OK** to enter its submenu and press **OK** again to confirm.

→ The registration code will appear.

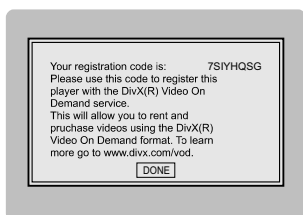

- Press **OK** to exit.
- Use the registration code to purchase or rent the videos from DivX® VOD service at [www.divx.com/vod](http://www.divx.com/vod). Follow the instructions and download the video onto a CD-R for playback on this DVD player.

### Notes:

- All the downloaded videos from DivX® VOD can only be played back on this DVD player.
- Time search feature is not available during DivX movie playback.

## LANGUAGE SETUP

The options included in LANGUAGE SETUP page are: "OSD LANGUAGE", "AUDIO LANG", "SUBTITLE LANG" and "MENU LANG". See "Preparations-Step 4: Setting language preference" for details.

## VIDEO SETUP

The options included in VIDEO SETUP page are: "COMPONENT", "TV MODE", "BRIGHTNESS", "CONTRAST", "HUE" and "SATURATION".

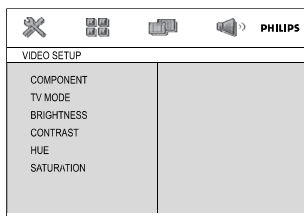

### COMPONENT

Sets the video output according to your video connection. This setting is not required if you are using the **VIDEO OUT** jack (yellow) to connect the DVD micro system to your TV.

→ **Pr/Cr Pb/Cb Y**: Select this if you have connected the DVD micro system to your TV using Component video jacks.

→ **SVIDEO**: Select this if you have connected the DVD micro system to your TV using S-Video jack.

→ **TV-RGB**: Select this if you have connected the DVD micro system to your TV using SCART jack.

### TV MODE

Selects interlace or P-SCAN video output mode when **Pr/Cr Pb/Cb Y** is selected.

→ **P-SCAN** and **INTERLACE**.

In the progressive scan mode, you can enjoy the high quality picture with less flickers. It only works when you have connected the DVD player's Y Pb Pr jacks to your TV that supports the progressive video input. Otherwise, a distorted picture will appear on the TV. For proper progressive scan set up, see "Preparations-Setting up Progressive Scan feature".

# System Menu Options

## BRIGHTNESS

Adjusts the brightness level. Range: 0-12.

## CONTRAST

Adjusts the contrast level. Range: 0-12.

## HUE

Adjusts the hue level. Range: -6-+6.

## SATURATION

Adjusts the saturation level. Range: 0-12.

## AUDIO SETUP

The options included in AUDIO SETUP page are: "DIGITAL OUT", "DOWNMIX", "3D PROCESSING", "LPCM" and "NIGHT MODE".

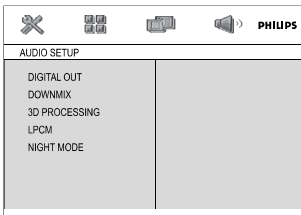

## DIGITAL OUT

- **DIGITAL/OFF**: Turns off the digital output.
- **DIGITAL/RAW**: If you have connected your DIGITAL OUT to a multi-channel decoder/ receiver.
- **DIGITAL/PCM**: Only if your receiver is not capable of decoding multi-channel audio.

## DOWNMIX

This options allows you to set the stereo analogue output of your DVD Player:

- **LT/RT**: Select this option if your DVD Player is connected to a Dolby Pro Logic decoder.
- **STEREO**: Select this option when output delivers sound from only the two front speakers.
- **VSS**: Allows the DVD player to use virtual surround sound effects.

## 3D PROCESSING

3D processing provides a virtual surround sound experience using just two speakers.

→ **OFF, CONCERT, CHURCH, PASSIVE, WIDE and LIVE**

## LPCM

If you connect the DVD Player to a PCM compatible receiver via the coaxial terminal, you may need to adjust 'LPCM'.

Discs are recorded at a certain sampling rate. The higher the sampling rate, the better the sound quality.

- **48kHz**: Playback a disc recorded at the sampling rate of 48kHz.
- **96kHz**: Playback a disc recorded at the sampling rate of 96kHz.
- **192kHz**: Playback a disc recorded at the sampling rate of 192kHz.

## NIGHT MODE

- **OFF**: Select this when you want to enjoy the surround sound with its full dynamic range.
- **ON**: Select this to level out the volume. High volume outputs will be softened and low volume outputs are brought upward to an audible level. This feature is only available for movies with Dolby Digital mode.

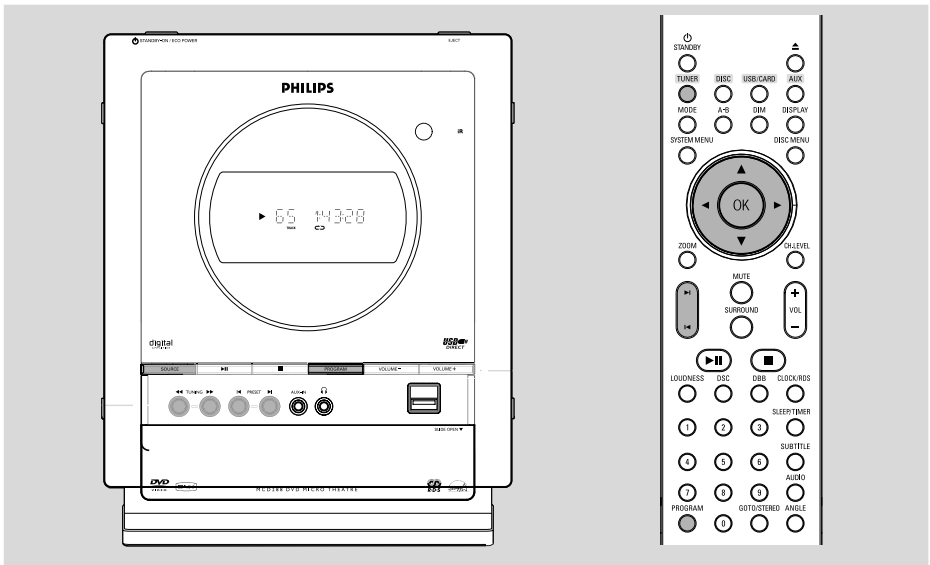

## Tuning to radio stations

- 1 Press **SOURCE** on the set repeatedly or **TUNER** on the remote to select FM tuner source.
- 2 Press and hold **TUNING** ◀◀/▶▶ (◀▶ on the remote) and release the button.  
→ The radio automatically tunes to a station with sufficient reception.
- 3 Repeat step 2 if necessary until you find the desired station.
- To tune to a weak station, press **TUNING** ◀◀/▶▶ (◀▶ on the remote) briefly and repeatedly until you have found optimal reception.

## Programming radio stations

You can store up to a total of 20 FM radio stations in the memory.

### Automatic programming

Press **PROGRAM** for more than three seconds to activate programming.  
→ All available stations are programmed.  
→ **AUTO** is displayed and available stations are programmed in order of waveband.

### Manual programming

- 1 Tune to your desired station (refer to "Tuning to radio stations").
- 2 Press **PROGRAM** to activate programming.  
→ **PROG** flashes on the display.
- 3 Press **PRESET** ◀◀/▶▶ to allocate a number from 1 to 20 to this station.
- 4 Press **PROGRAM** again to confirm the setting.  
→ **PROG** disappears.
- 5 Repeat the above four steps to store other stations.
- You can override a preset station by storing another frequency in its place.

### Tuning to preset radio stations

- Press **PRESET** ◀◀/▶▶ until the desired preset station is displayed.

## RDS

**Radio Data System** is a service that allows FM stations to show additional information. If you are receiving a RDS station, **R-D-S** and the station name are displayed.

### Scrolling through different RDS information

- Press **CLOCK/RDS** briefly and repeatedly to scroll through the following information (if available):
  - Station name
  - RDS clock
  - Programme type such as *NEWS, SPORT, POP M* ...
  - Frequency

### Setting the RDS clock

Some RDS radio station may be transmitting a real clock time at an interval of every minute. It is possible to set the clock by using a time signal which is broadcast together with the RDS signal.

- 1 Tune to a RDS station from FM band (refer to "Tuning to radio stations").
- 2 Press **CLOCK/RDS**.
  - "RDS 00:00" appears..
  - If the RDS station does not transmit RDS time, "RDS CLOCK" appears.

#### Note:

– *Some RDS radio station may be transmitting a real time clock at a minute interval. The accuracy of the transmitted time depends on the transmitting RDS radio station.*

## Using a non-USB device

- 1 Connect the system's **AUX-IN** jack to the **AUDIO OUT** jacks on another audio/visual device (such as a VCR, Laser Disc player or cassette deck) using a "single-to-double" cinch cable (with one end providing a 3.5" connector for connection to the **AUX-IN** jack while the other end providing two white/red connectors for connection to the other device's AUDIO OUT jacks).
- 2 Press **AUX** to select external equipment.  
→ "FLU" is displayed.

### Note:

- All the sound control features (DSC or DBB, for example) are available for selection.
- Refer to the operating instructions for the connected equipment for details.

## Using a USB mass storage device

By connecting a USB mass storage device to the Hi-Fi system, you can enjoy the device's stored music through the powerful speakers of Hi-Fi system.

### Playing a USB mass storage device Compatible USB mass storage devices

With the Hi-Fi system, you can use:

- USB flash memory (USB 2.0 or USB1.1)
- USB flash players (USB 2.0 or USB1.1)
- memory cards (requires an additional card reader to work with this Hi-Fi system)

### Note:

- In some USB flash players (or memory devices), the stored contents are recorded using copyright protection technology. Such protected contents will be unplayable on any other devices (such as this Hi-Fi system).

### Supported formats:

- USB or memory file format FAT12, FAT16, FAT32 (sector size: 512 bytes)
- MP3 bit rate (data rate): 32-320 Kbps and variable bit rate
- WMA v9 or earlier
- Directory nesting up to a maximum of 8 levels
- Number of albums/ folders: maximum 99
- Number of tracks/titles: maximum 999
- ID3 tag v2.0 or later
- File name in Unicode UTF8 (maximum length: 128 bytes)

### The system will not play or support the following:

- Empty albums: an empty album is an album that does not contain MP3/WMA files, and will not be shown in the display.
- Non-supported file formats are skipped. This means that e.g.: Word documents .doc or MP3 files with extension .dlf are ignored and will not be played.
- AAC, WAV, PCM audio files
- DRM protected WMA files
- WMA files in Lossless format

### How to transfer music files from PC to a USB mass storage device

By dragging and dropping music files, you can easily transfer your favorite music from PC to a USB mass storage device.

For the flash player, you can also use its music management software for the music transfer.

**However, those WMA files may be unplayable for compatibility reasons.**

# External Sources

## How to organize your MP3/WMA files on the USB mass storage device

This Hi-Fi system will browse the MP3/WMA files in the folders/sub-folders/titles order:

Example:

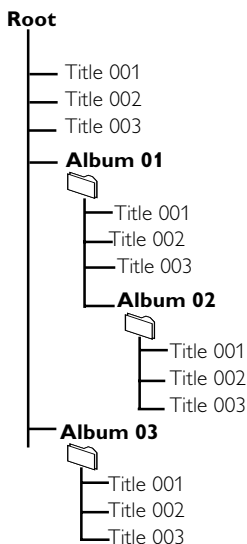

Organize your MP3/WMA files in different folders or subfolders as required.

Notes:

- If you have not organized MP3/WMA files into any albums on your disc, an album "00" will be automatically assigned for all those files.
- Make sure that the file names of MP3 files end with `.mp3` and the file names of WMA files end with `.wma`.
- For DRM protected WMA files, use Windows Media Player 10 (or later) for conversion. Visit [www.microsoft.com](http://www.microsoft.com) for details about Windows Media Player and WM DRM (Windows Media Digital Rights Management).

- 1 Check the USB device has been properly connected. (See Installation: Connecting an additional appliance).
- 2 Press **SOURCE** once or more to select USB (or **USB/CARD** on the remote control). **NO AUDIO** appears if no audio file is found in the USB device.

- 3 Play the USB's audio files as you do with the albums/tracks on a CD (See Disc Operations).

Notes:

- For compatibility reasons, the album/track information may differ from what it is displayed through flash players' music management software.
- File names or ID3 tags will be displayed as — if they are not in English.

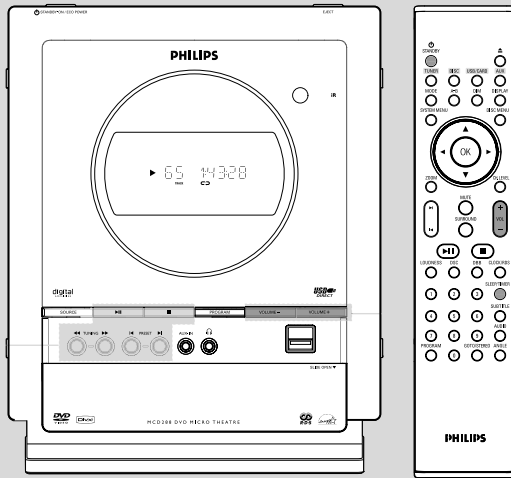

## Clock setting

See "Preparations-Step 2: Setting the clock".

## Timer setting

- The system can be used as an alarm clock, whereby the last selected source is switched on at a set time (one time operation). The clock time needs to be set first before the timer can be used.
- 1 In standby mode, press and hold **SLEEP/TIMER** for more than three seconds.  
→ "TIMER SET" is displayed briefly. Then, the hour digits flash on the display panel.
- 2 Press **VOLUME +/- (VOL +/-)** on the remote) to set the hours and **SLEEP/TIMER** to confirm.  
→ The minute digits flash on the display panel.
- 3 Press **VOLUME +/- (VOL +/-)** on the remote) to set the minutes and **SLEEP/TIMER** to confirm.  
→ "TUN", "D/D" or "USB" flashes.
- 4 Press **VOLUME +/- (VOL +/-)** on the remote) to select your desired source.
- 5 Press **SLEEP/TIMER** to complete the setting.  
→ Display shows

## To deactivate the timer

- Press **SLEEP/TIMER** again.  
→ disappears.

## Sleep timer setting

The sleep timer enables the system to switch off by itself after a set period of time.

- 1 Press **SLEEP/TIMER** on the remote control repeatedly to select a preset time.  
→ The selections are as follows (time in minutes):  
OFF → 15 → 30 → 45 → 60 → 75 → 90 → 105 → 120 → OFF  
→ "SLEEP xx" or "SLEEP OFF" is displayed. "xx" is the time in minutes.
  - 2 When you reach the desired length of time, stop pressing **SLEEP/TIMER**.  
→ Display shows  $\cdot\cdot\cdot\cdot$ .
- ## To deactivate the sleep timer
- Press **SLEEP/TIMER** repeatedly until "00" is displayed, or press **STANDBY-ON** (**STANDBY** on the remote).  
→  $\cdot\cdot\cdot\cdot$  disappears.

# Specifications

## AMPLIFIER

Output power .....	100 W RMS
Signal-to-noise ratio .....	≥ 65 dBA
Frequency response .....	150 – 20000 Hz, ± 3 dB
Input sensitivity AUX .....	0.5 V (max. 2 V)
Impedance loudspeakers .....	6 Ω
Impedance headphones .....	32 Ω -1000 Ω

## DVD PLAYER

Laser Type .....	Semiconductor
Disc Diameter .....	12cm / 8cm
Video Decoding .....	MPEG-2 / MPEG-1
Video DAC .....	10 Bits
Signal System .....	PAL / NTSC
Video Format .....	4:3 / 16:9
Video S/N .....	56 dB (minimum)
Composite Video Output .....	1.0Vp-p, 75 Ω
S-Video Output .....	Y - 1.0Vp-p, 75 Ω
..... C - 0.286Vp-p, 75 Ω	
Audio DAC .....	24 Bits / 96 kHz
Frequency Response ... 4 Hz - 20 kHz (44.1kHz)	
..... 4 Hz - 22 kHz (48kHz)	
..... 4 Hz - 44 kHz (96kHz)	
Digital Output .....	
..... SPDIF (Sony Philips digital interface) Coaxial	
Number of programmable tracks .....	16
Signal-to-noise ratio .....	≥ 65 dBA
Channel separation .....	≥ 40 dB (1 kHz)
Total harmonic distortion .....	< 0.1% (1 kHz)

## USB PLAYER

USB .....	12Mb/s, V1.1
.....	support MP3 and WMA files
Number of albums/folders .....	maximum 99
Number of tracks/titles .....	maximum 999

## TUNER

FM wave range .....	87.5 – 108 MHz
Sensitivity at 75 Ω	
– mono, 26 dB signal-to-noise ratio .....	2.8 μV
– stereo, 46 dB signal-to-noise ratio .....	61.4 μV
Selectivity .....	≥ 15 dB
Total harmonic distortion .....	≤ 5%
Frequency response .....	40 – 5000 Hz (-6 dB)
Signal-to-noise-ratio .....	≥ 58 dBA

## SPEAKERS

### Front Speakers

Impedance .....	6 Ω
Sensitivity .....	80 ± 4dB
Frequency response .....	150Hz-20kHz
Dimensions ... 140 (W) x 220 (H) x 33 (D) mm	
Weight .....	6.6 kg/each

### Subwoofer

Subwoofer (not magnetically shielded design) .....	8"
Impedance .....	8 Ω
Output power .....	60 W
Dimensions (w x h x d) .....	
.....	170 mm x 197 mm x 302 mm
Weight .....	10.6 kg

## GENERAL INFORMATION

AC Power .....	220 / 50 Hz
Dimensions (w x h x d) ..	200 x 250 x 110 (mm)
Weight(with/without speakers) .....	7.1 / 3.5 kg
Standby power consumption .....	≤ 4W

**Specifications and external appearance are subject to change without notice.**



## WARNING

**Under no circumstances should you try to repair the system yourself, as this will invalidate the warranty. Do not open the system as there is a risk of electric shock.**

**If a fault occurs, first check the points listed below before taking the system for repair. If you are unable to remedy a problem by following these hints, consult your dealer or Philips for help.**

Problem	Solution
<b>No power.</b>	<ul style="list-style-type: none"> <li>✓ Check if the AC power cord is properly connected.</li> </ul>
<b>“NO DISC” is displayed.</b>	<ul style="list-style-type: none"> <li>✓ Check if the disc is inserted upside down.</li> <li>✓ Wait until the moisture condensed at the lens has cleared.</li> <li>✓ Replace or clean the disc, see “Maintenance”.</li> <li>✓ Use a readable disc or correctly recorded format MP3-CD.</li> </ul>
<b>No picture.</b>	<ul style="list-style-type: none"> <li>✓ Select the appropriate video input mode on the TV set.</li> <li>✓ Check if the TV set is switched on.</li> <li>✓ Check the video connection.</li> <li>✓ Check if the system is securely connected.</li> <li>✓ If the progressive scan feature is activated but the connected TV does not support progressive signals or the cables are not connected accordingly, see “Preparations-Setting up Progressive Scan feature” for proper progressive scan setup or deactivate the progressive scan feature as below:               <ol style="list-style-type: none"> <li>1) Turn off your TV progressive scan mode or turn on to interlaced mode.</li> <li>2) Press SYSTEM on the remote to exit the system menu and then DISC to exit progressive scan.</li> </ol> </li> </ul>
<b>Distorted or poor picture.</b>	<ul style="list-style-type: none"> <li>✓ Sometimes a slight picture distortion may appear. This is not a malfunction.</li> <li>✓ Clean the disc.</li> <li>✓ Connect the system to the S-video input of your TV set.</li> </ul>
<b>The aspect ratio of the screen cannot be changed even though you have set the TV shape.</b>	<ul style="list-style-type: none"> <li>✓ The aspect ratio is fixed on the DVD disc.</li> <li>✓ The aspect ratio may not be changed for some TV systems.</li> </ul>

# Troubleshooting

Problem	Solution
<b>The DVD player does not start playback.</b>	<ul style="list-style-type: none"><li>✓ Insert a readable disc.</li><li>✓ Check the disc type, color system and region code.</li><li>✓ Clean the disc.</li><li>✓ Place the disc with the playback side down.</li><li>✓ Press SYSTEM MENU to turn off the setup menu.</li><li>✓ Cancel the parental control rating function or change the rating level.</li><li>✓ Moisture has condensed inside the system. Remove the disc and leave the system turned on for about an hour.</li></ul>
<b>The DVD player does not respond when buttons are pressed.</b>	<ul style="list-style-type: none"><li>✓ Disconnect the power plug from the jack, and insert again.</li></ul>
<b>The language for the sound or subtitle cannot be changed when playing a DVD.</b>	<ul style="list-style-type: none"><li>✓ Multi-language sound or subtitle is not recorded on the DVD.</li><li>✓ Changing the language for the sound or subtitle is prohibited on the DVD.</li></ul>
<b>No image is output when a function is selected.</b>	<ul style="list-style-type: none"><li>✓ Make sure the component is connected correctly.</li><li>✓ Press the correct function button for the input source.</li></ul>
<b>Sound cannot be heard or is of poor quality</b>	<ul style="list-style-type: none"><li>✓ Adjust the volume.</li><li>✓ Disconnect the headphones.</li><li>✓ Check that the speakers are connected correctly.</li><li>✓ Check if the stripped speaker wire is clamped.</li><li>✓ If the system is in pause, slow motion or fast forward/reverse mode, press PLAY/PAUSE ►   to resume the normal play mode.</li><li>✓ Make sure the MP3-CD was recorded within 32-256 kbps bit rate with sampling frequencies at 48 kHz, 44.1 kHz or 32 kHz.</li><li>✓ Ensure that the DTS disc also supports Dolby Digital output.</li></ul>
<b>Poor radio reception.</b>	<ul style="list-style-type: none"><li>✓ If the signal is too weak, adjust the antenna or connect an external antenna for better reception.</li><li>✓ Increase the distance between the System and your TV set or VCR.</li></ul>

Problem	Solution
<b>Recording or playback cannot be made</b>	<ul style="list-style-type: none"> <li>✓ Clean deck parts, see "Maintenance".</li> <li>✓ Use only NORMAL tape.</li> <li>✓ Apply a piece of adhesive tape over the missing tab space.</li> </ul>
<b>Left and right sound outputs are reversed.</b>	<ul style="list-style-type: none"> <li>✓ Check the speaker connections and location.</li> </ul>
<b>The remote control does not function.</b>	<ul style="list-style-type: none"> <li>✓ Point the remote control at the remote control sensor of the unit.</li> <li>✓ Reduce the distance to the player.</li> <li>✓ Remove any possible obstacles.</li> <li>✓ Replace the batteries with new ones.</li> <li>✓ Check that the batteries are loaded correctly.</li> </ul>
<b>The timer is not working</b>	<ul style="list-style-type: none"> <li>✓ Set the clock correctly.</li> <li>✓ If recording is in progress, stop it</li> </ul>
<b>The Clock/Timer setting is erased</b>	<ul style="list-style-type: none"> <li>✓ Power has been interrupted or the power cord has been disconnected. Reset the clock/timer.</li> </ul>
<b>No sound and picture</b>	<ul style="list-style-type: none"> <li>✓ Check that the RGB/SCART cable is connected to the correct device (See Connecting TV).</li> </ul>
<b>Some files on the USB device are not displayed.</b>	<ul style="list-style-type: none"> <li>✓ Check if the number of folders exceeds 99 or the number of titles exceeds 999.</li> </ul>

**Analog:** Sound that has not been turned into numbers. Analog sound varies, while digital sound has specific numerical values. These jacks send audio through two channels, the left and right.

**Aspect ratio:** The ratio of vertical and horizontal sizes of a displayed image. The horizontal vs. vertical ratio of conventional TVs is 4:3, and that of wide-screens is 16:9.

**AUDIO OUT Jacks:** Jacks on the back of the DVD System that send audio to another system (TV set, Stereo, etc.).

**Bit Rate:** The amount of data used to hold a given length of music; measured in kilobits per second, or kbps. Or, the speed at which you record. Generally, the higher the bit rate the better the sound quality. However, higher bit rates use more space on a Disc.

**Chapter:** Sections of a picture or a music piece on a DVD that are smaller than titles. A title is composed of several chapters. Each chapter is assigned a chapter number enabling you to locate the chapter you want.

**Component Video Out Jacks:** Jacks on the back of the DVD System that send high-quality video to a TV set that has Component Video In jacks (R/G/B, Y/Pb/Pr, etc.).

**Disc menu:** A screen display prepared for the selection of images, sound, subtitles, multi-angles, etc recorded on a DVD.

**Digital:** Sound that has been converted into numerical values. Digital sound is available when you use the DIGITAL AUDIO OUT COAXIAL or OPTICAL jacks. These jacks send audio through multiple channels, instead of just two channels as analog does.

**Dolby Digital:** A surround sound system developed by Dolby Laboratories containing up to six channels of digital audio (front left and right, surround left and right and center).

**DTS:** Digital Theater Systems. This is a surround sound system, but different from Dolby Digital. The formats were developed by different companies.

**JPEG:** A still-picture data compression system proposed by the Joint Photographic Expert Group, which features small decrease in image quality in spite of its high compression ratio.

**MP3:** A file format with a sound data compression system, "MPE" is the abbreviation of Motion Picture Experts Group 1 (or MPEG-1) Audio Layer 3. Through the MP3 format, one CD-R or CD-RW can contain about 10 times as much data volume as a regular CD can.

**Multichannel:** DVD is specified to have all sound tracks constitute one sound field. Multichannel refers to a structure of sound tracks having three or more channels.

**Parental control:** A function of the DVD to limit playback of the disc by the age of the users according to the limitation level in each country. The limitation varies from disc to disc; when it is activated, playback will be prohibited if the software's level is higher than the user-set level.

**PCM (Pulse Code Modulation):** A system for converting analog sound signal to digital signal for later processing without data compression.

**Playback control (PBC):** Refers to the signal recorded on video CDs or SVCDs for reproduction control. By using screen menus recorded on a Video CD or SVCD that supports PBC, you can enjoy interactive-type software as well as software having a search function.

**Progressive Scan (P-Scan):** It displays all the horizontal lines of a picture at one time, as a signal frame. This system can convert interlaced video from DVD into progressive format for connection to a progressive display. It dramatically increases the vertical resolution. A progressive scan TV set is needed to receive progressive scan output from the system.

**Region code:** A system allowing discs to be played only in preset regions. This unit will only play discs that have compatible region codes. You can find the region code of your unit from the product label. Some discs are compatible with more than one region (or ALL regions).

**S-Video:** Produces a clear picture by sending separate signals for luminance and the color. You can use S-Video only if your TV set has S-Video In jack.

**Sampling Frequency:** Frequency of data sampling when analog data is converted to digital data. Sampling frequency numerically represents how many times the original analog signal is sampled per second.

**Surround:** A system for users to create realistic three-dimensional sound fields full of realism by arranging multiple speakers around the listener.

**Title:** The longest section of a picture or music feature on DVD, music, etc., in video software, or the entire album in audio software. Each title is assigned a title number enabling you to locate the title you want.

**VIDEO OUT jack:** Jack on the back of the DVD System that sends video to TV.